

ZANDVANGER GLASVEZEL BETON B=150 L=500 KLASSE B T/M F

€353.32 incl. BTW

€292.00 excl. BTW

SKU: AMT 50.11052-01



1

Aqua Milieu Techniek levert draingoten in verschillende maten, lengtes, verkeersafdekkingen. Afvoergoten van hoogwaardige kwaliteit, glasvezelversterkt beton.

VARIATIONS







Image	SKU	Description	Type rooster
	AMT 11000-11061-1-1	Afvoergoot type AMTKS150 inclusief gietijzeren sleufrooster verkeersklasse F 900 kN	Gietijzeren sleufrooster F 900 kN.

Image	SKU	Description	Type rooster
	AMT 11000-11068-1-1	Afvoergoot type AMTKS150 inclusief gietijzeren sleufrooster verkeersklasse E 600 kN	Gietijzeren sleufrooster E 600 kN.
	AMT 11000-11463-1-1	Afvoergoot type AMTKS150 inclusief gietijzeren sleufrooster verkeersklasse D 400 kN	Gietijzeren sleufrooster D 400 kN.
	AMT 11000-11064-1-1	Afvoergoot type AMTKS150 inclusief gietijzeren sleufrooster verkeersklasse C 250 kN	Gietijzeren sleufrooster C 250 kN.
	AMT 11000-11075-1-1	Afvoergoot type AMTKS150 inclusief verzinktstalen maasrooster (30/10) verkeersklasse C 250 kN	Verzinktstalen maasrooster (30/10) C 250 kN.
	AMT 50.11000-47170-1-1	Afvoergoot type AMTKS150 inclusief zwart design stavenrooster type FIBRETEC B125 kN	FIRETEC Design stavenrooster B 125 kN.



PRODUCT DESCRIPTION

Afvoergoot, glasvezel versterkt beton - Aqua Milieu Techniek -

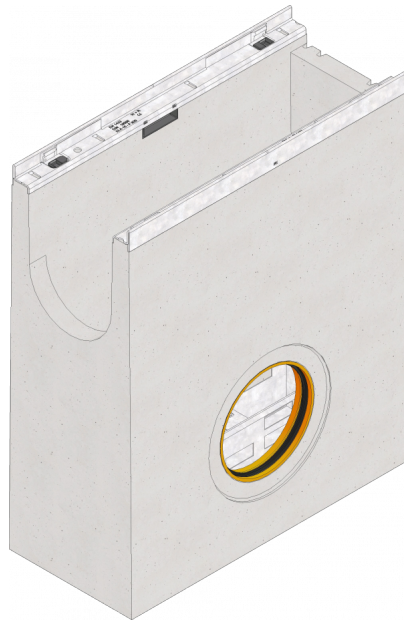
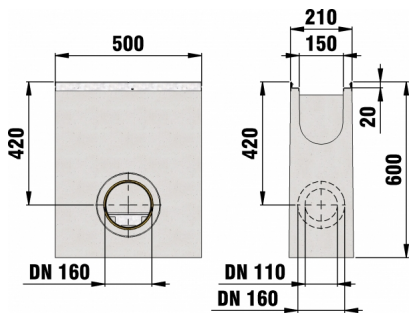
[Catalogus blad downloaden](#). Wijzigingen voorbehouden.

Type	AMT 50.11052-01
Materiaal	Glasvezelversterkt beton voorzien van verzinktstalen hoeklijn.
Afmetingen uitwendig	500 x 600 x 210 mm (LxHxB)
Afmetingen inwendig	500 x 550 x 150 mm (LxHxB)
Gewicht	66 kg.
Afdekking	Naar keuze; keuze uit verkeersklasse A 15 kN, B 125 kN, C 250 kN, D 400 kN, E 600 kN, 900 kN.
Optioneel	Elementen van 100 mm, 500 mm., kopplaten gesloten, eindplaten met doorvoering/uitlaat, bijhorend rooster.

1

